

# lichtblick

ISSUE 51 | DECEMBER 2022

**Julia Wienold:**  
“I’m thrilled every time  
a patent is granted”

PAGE 4

Picture: Michael Seifert

EN

# TABLE OF CONTENTS

COVER STORY ..... 4



**“I’m thrilled every time a patent is granted”**

Patent assessor Julia Wienold

CONVERSATION ..... 8



**How do you say goodbye to a fulfilling professional life?**

Interview of Christian Jung

IN THE SPOTLIGHT ..... 12

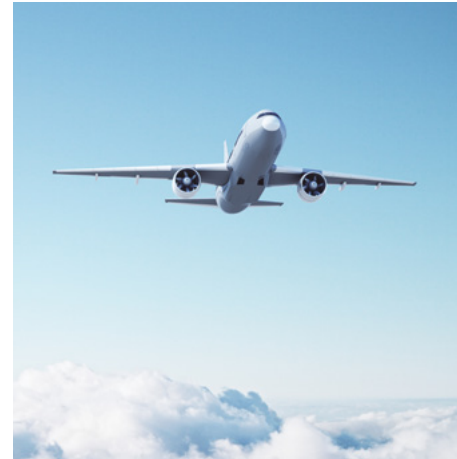

**Sustainable fuels for aviation**

A South African-German research project picks up speed

**LICHTBLICK MAGAZINE IN A NEW GUISE:**

The digital read is now easy ..... 7

**MOBILITY SURVEY:**

How do we get to work? ..... 17

**RESEARCH FOR A CLIMATE-NEUTRAL SOCIETY:**

HZB strategy has been published ..... 21

Development of the campuses ..... 19

Prizes and Personnel ..... 23

Picture puzzle ..... 24

Visit of the science minister ..... 25

Recipes from all over the world ..... 26

## Three questions for Bernd Rech



### **What is the biggest challenge for Management at the moment?**

**Bernd Rech:** The biggest challenge is the one that troubles us all privately: the energy crisis and our concern about Russia's war against Ukraine. Under these conditions, we have to see ourselves safely through the winter and continue successfully conducting our research.

### **What's the sort of news you would like the day to start with?**

With good or better news from the radio, over a cup of coffee. It's especially pleasing when the day starts with some good news from our Centre. For example, when I hear that someone has won a prize, or a great paper has been accepted, or our infrastructure projects are coming along nicely. I enjoy every positive piece of news from the Centre.

### **We are nearing the end of the year. Looking back, what things went particularly well at HZB?**

The HZB Supervisory Board has just newly passed the strategy for HZB, which we have published in a brochure. We have introduced two successful proposals for BESSY II and BESSY III, with support from international experts. This gives us a strong tailwind, as do the exciting projects from energy research. We are gaining a lot of political and social visibility from all this. These are great achievements made by everyone at the Centre. We can all be proud of that.

Interview conducted by Stefanie Kodalle and Silvia Zerbe



Picture: Michael Seppelhardt

**Julia Wienold:**  
“The conversations are inspiring  
and I always learn new things.”

A team from the protontherapie (from left: Jürgen Bundesmann, Timo Fanselow, Alina Dittwald) explains to the patent assessor Julia Wienold (left) how the new camera works. In the meantime this has been submitted for a patent.

COVER STORY

# “I’m thrilled every time a patent is granted”

Whenever Julia Wienold receives a letter from Munich, there is a sense of excitement. Is this going to be a new patent for HZB? Munich is where the German Patent and Trade Mark Office and the European Patent Office are based, who send the examination reports by post to HZB. “I’m still thrilled every time a patent is granted. Because, no matter how well we prepare for it, it’s ultimately a patent examiner at the office who decides whether we get the patent or not,” she says. Julia Wienold is the patent assessor at HZB. The job sounds complicated. To become a patent assessor, you not only have to pass a state examination in patent law, you also have to prove that you have eight to ten years of professional experience in this field. Such high entry requirements did not deter Julia Wienold from pursuing this career path. The mineralogist joined the Patents workgroup at HZB in November 2011. First she passed the examination to become a European patent attorney, after which she studied law for patent attorneys while working, and then passed the exam to become a patent assessor in June 2020. “It really was a dive into

When it comes to inventions and patents at HZB, everything goes through Julia Wienold. The specialist gives tips on what to consider and why a patent makes sense for the inventor.

the deep end because I had never had anything to do with law or patents before. The first time I looked through the exam papers, I didn’t understand a thing.” Before coming to HZB, Julia Wienold was a scientist, heart and soul. After studying mineralogy in Aachen, she did her doctorate at the Fritz Haber Institute, supervised by Robert

Schlögl, on the in situ characterisation of metal oxide catalysts. She then moved to Hamburg to head an experimental station at DORIS II at the DESY research centre. At that point, she became pregnant with her first child. Because her partner had a permanent job in Berlin, they moved to the capital. After her maternity leave, she took a job at

the Federal Institute for Materials Research and Testing, worked in the lab and developed methods for quality testing. Julia Wienold still draws on her scientific background today. She can quickly get up to speed on all kinds of topics whenever an invention disclosure lands on her desk. So, what does the patenting process look like? “Anyone who makes an invention at HZB can simply contact me, by phone or email, or they can fill out an invention disclosure form directly,” she explains. Then the work begins for her: she researches patent databases,



Patent certificates from China, Japan and the USA (from left to right): For some patents HZB applies in several countries. The step is worth it, if you can expect licensing income.

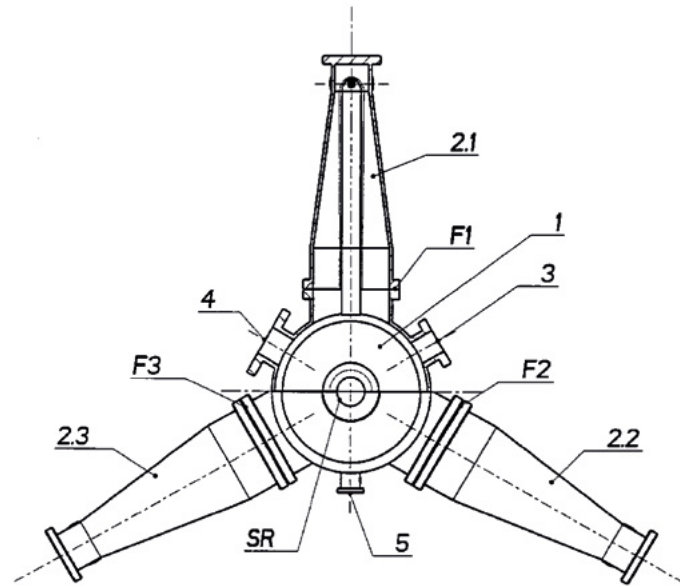

publication servers or the Internet to find out what the state of the art is. Because behind every patentable invention there has to be a genuine innovation. “If you’ve only optimised one small screw on a machine, you will not be successful in applying for a patent.” In their first interview, she gives the inventors an important piece of advice: “First apply for a patent, then publish.” If an invention has already been published in whatever form – for example, at a conference, on a website or as a so-called “pre-print” – then the chance of obtaining a patent is gone. Sometimes, she only finds out about an invention at the last minute. “I have received calls even one day before publication,” she says. In such

With this patent from 2003 HZB generates the most licensing income. The illustration shows a HOM-damped cavity resonator, an important component for the generation of synchrotron radiation.

cases, she tries to save what can be saved. If necessary, she can use parts of the publication to apply for the patent and then submit the rest of the specifications later. What counts is the filing date – and that must be before publication. If all goes well, the patent will be granted by the German Patent Office or another patent

office. But what happens then? Twice a year, the Patents workgroup meets with Management and Technology Transfer to make decisions. There, they discuss what will be done with the patents: In what other countries should the invention be patented? And how do you find someone who is interested in using the patent? The answers depend very much on the patent in question and its market potential. For example, getting a European patent is expensive, so you have to calculate whether it’s worth it.

Julia Wienold loves the contact with researchers in her work. “The conversations are inspiring and I always learn new things,” she says. In some subject areas, for example chemistry, she will work together with an external firm. And there are those times when too many inventions come flooding in – as happened last year, when 24 invention disclosures were submitted all at once, which she and her colleague Chantal-Sophie Amelang processed together. Despite all this, she is happy for every disclosure that comes in. “Funders and even society expect scientific knowledge to be transferred – and that’s where patents and licensing become an important component,” she says. Being involved in a patent is not just a point of prestige to put on your CV. What is more, inventors at HZB receive a bonus and a share of the licensing income. These are the kinds of messages that she takes to the scientists in their many fields, to tell them exactly how

the whole invention patenting thing works. Incidentally, aside from patents, Julia Wienold sometimes finds herself spending half her time working on another task: checking cooperation agreements to ensure that there is fair ruling on the joint exploitation when sharing the results between parties.

Working in so many fields can become very intense at times, Julia Wienold says. But she has found a good way to compensate for it. Ever since the first lockdown, she takes even more time for her yoga sessions than before. “It just does me good, and I draw a lot of strength from it,” she says before diving straight back into her work.

■ BY SILVIA ZERBE

## 24

[inventions have been submitted at the patent group by HZB employees in 2021.](#)

# LICHTBLICK MAGAZINE IN A NEW GUISE

You have probably already noticed: lichtblick is now only "half the size". We have changed the HZB magazine to a new format so that it is even easier to read on a computer or a laptop. For all those who prefer to have a real magazine in their hands, there is still a printed edition (in German).



**WHERE CAN I GET LICHTBLICK MAGAZINE?**  
The magazine is sent out to you directly via email. You will also find a few printed issues in German at HZB, for example in some copy rooms, sitting areas or secretary offices.

## WHAT IS NEW

- For the first time there is a **digital version in English**. During a one-year test period we would like to see if this issue is well received.
- We focus on the **digital edition**. Many contents are directly linked to further information or videos.
- Overall, there are fewer long texts but shorter information tidbits that can be consumed easier on the screen.
- **Good for the environment**: there are less printed issues. For the printing we use certified recycled paper and offset the CO<sub>2</sub> emissions.

## WHAT DO YOU THINK?

We are very curious to know all your thoughts about the new lichtblick!



Send us an email:  
[lichtblick@helmholtz-berlin.de](mailto:lichtblick@helmholtz-berlin.de)

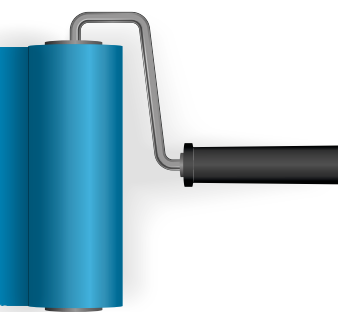

## CONVERSATION WITH CHRISTIAN JUNG

# How do you say goodbye to a fulfilling professional life?

Christian Jung is an institution unto himself. The longstanding head of department is known to everyone at BESSY II. He is now retiring in July 2022 – a real turning point. In this interview, he talks about how the transition is going for him and why he still comes into the office a few days a week.

**Dr. Jung, you officially went into retirement on the 1st of July. Is your time at HZB now at an end?**

**Christian Jung:** I was given a send-off by my colleagues on the 30th of June, but I am still coming in a few days a week. I signed an agreement that lets me continue to supervise the final phase of the “BelChem” project over the next eleven months. This is where we are installing three new measuring stations for catalysis research and solar energy research at BESSY II. It’s a complex project, and has

been delayed many times over. So, I will be happy to be able to finish it before I say goodbye for good. I gave up my leadership function on 30th of June, which is very important for me to emphasise. I am “just” a member of staff now; it’s up to others to make the decisions – and that’s a good thing! It’s a complete role reversal for me and my colleagues, but we are very happy with the way it is.

**A lot of people seem to retire with a happy smile but a heavy heart. How is it for you?**



It's the same for me, too. I'm leaving with a happy smile because there are outstanding people here at HZB and it's their turn now. Longstanding experience is important, but it can also make you blind. That's why it's good that others are in charge now. My former tasks are in good hands. We prepared this handover for a long time, and there was a smooth transition that ensures the proper degree of continuity. That's why it's easy for me to be leaving.

But, of course, I'm also leaving with a heavy heart: I've got so many wonderful colleagues and friends here. We've spent years, even decades, getting a lot done together. BESSY is simply a unique place. I will miss it very much.

#### What's the best thing about working at HZB?

The special atmosphere! There is so much helpfulness, creativity and commitment here. That impressed me back in 1985 already, when I was doing my doctorate at TU Berlin and came to BESSY I for the first time to do experiments. To this day, the focus is on cooperation, on what we have in common. We have a goal which we are all working towards together: our task is to ensure that BESSY continues to operate flawlessly. This is what we can do to enable valuable research – for our guest researchers and our own scientists. It's this idea of service that has always driven us and glued us together across departments.

#### Which project are you particularly proud of?

One project still stands out for me today because it was so complex. That was the system integration for the VSR module at BESSY II. It started with us having to make space in the experimental hall and dismantle some of the huts. The main part, installing the cold box and then establishing the media supplies for cold and electricity, was a demanding achievement technically and organisationally. We even had to open up the roof of the experimental hall. Working

**About Christian Jung:** he has a doctorate in physics and came in contact with accelerators for the very first time in 1985 – at that time at BESSY I in Wilmersdorf. Since then, he has been working at the interface between science and technology, organising reconstruction measures at BESSY II and advancing complex projects. And he still does it to this day, even though he has been retired for a few months.

with many internal and external experts, we finally pulled it off, and I am somewhat proud of that.

#### What would you say was the biggest faux pas you made?

Oh, I remember that well. It was back then, in the newly equipped optics basement at BESSY I. We needed a cylindrical mirror for a new monochromator, which we wanted to construct out of two mirrors. We designed a base plate for this apparatus and had it

manufactured for us. Unfortunately, when it came out of the workshop, the drill holes were wrong. Time was pressing and we had to improvise. I thought, "I can probably do something with this" and started making my own adjustments to the two mirrors in the basement. In the process, the whole construction, mirrors and all, fell right off the table. I ran straight out to tell our scientific director at the time, Prof. Gudat. His reaction impressed me. He didn't reproach me; he just asked: What can we do now to salvage the optics? The whole thing still affects me to this day. At the time, I let myself be talked into accepting something half-baked because

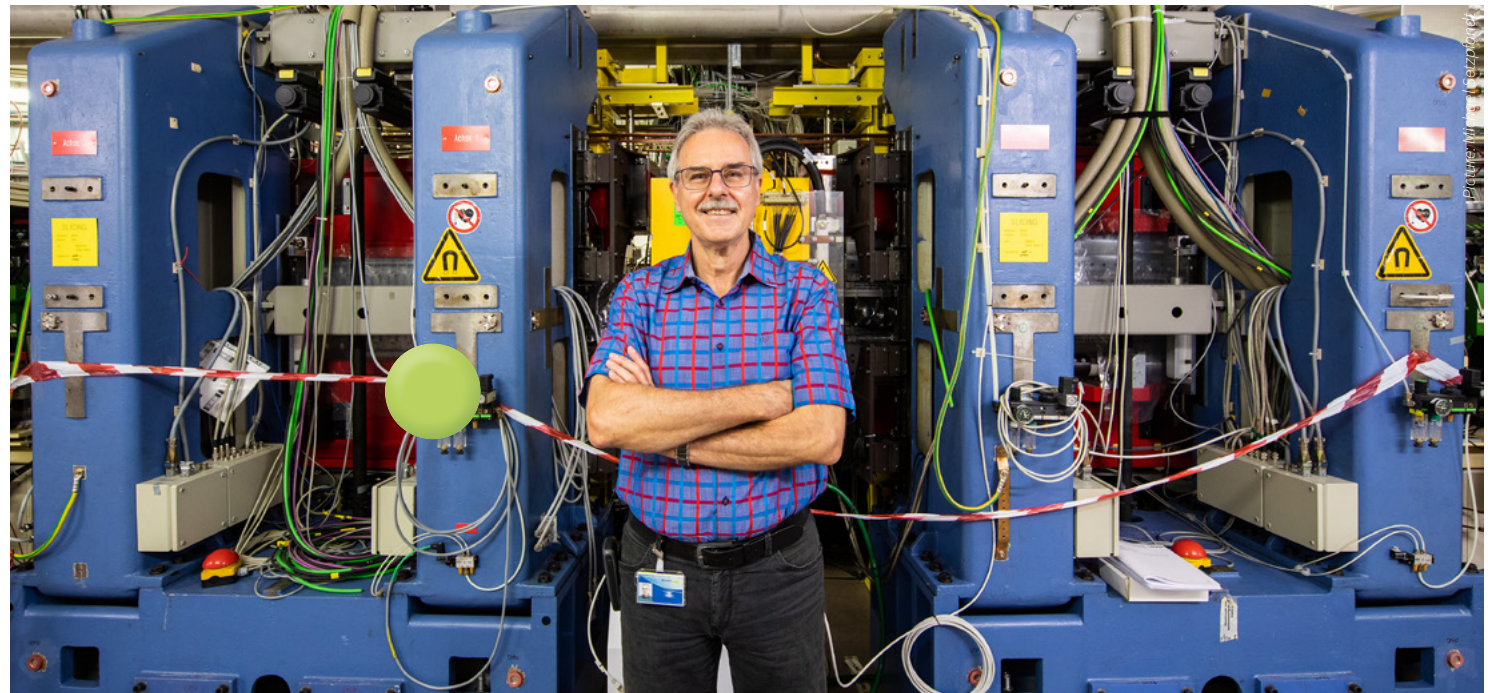

time was pressing. Since then, I make sure to check drawings and commissions even more carefully, and don't agree to improvised solutions if they are not good.

**We know you as a patient and helpful colleague. What is it that can make you lose your cool? Is that possible at all?**

It is possible, but I try not to let it show. I'm not one to raise my voice in meetings when I don't like something. What really drives me crazy is when people whinge. People can become displeased when things don't progress as fast as they had hoped. We do everything we can, but often things just can't go any faster. There are always legitimate reasons for this. But, it is never because we are not committed. Anyone who knows us should actually know that.

**What would your advice be now to your younger self?**

Maybe I would actually dare to put myself on the path to becoming a woodworker, so that I could work with my hands. I like working with wood and have even built one or two pieces of furniture at home. Back then, I chose to study physics and wanted to become a teacher. But then I took a different path, and am glad that I ended up here. I have always found the work to be extremely varied here at HZB. But still, I do enjoy the idea of working with my hands, so I really liked the fact that I got the chance to work closely with design and manufacturing at HZB.

**“After one year, that's it, I'm done. That's when I will have moved on to my new life.”**

**Christian Jung**

**How do you feel life will be in the future? What are you looking forward to?**

I don't have any sense of being retired or on leave yet, because I'm still at the office a lot. But I don't make the decisions anymore, so I have consciously taken a step back. Rather, I'm glad that I'm still able to help out, and that everyone thinks that's a good thing and is being very supportive. Once the BelChem measuring stations have been handed over to the user community at the beginning of 2023, I would like to work a lot less. Then I can answer this question better for you, because now I can only speculate on how life will be.

**It sounds as though retiring is not so easy for you....**

I have spent my entire working life here, and retiring really is a big deal. From those I know personally, I have seen how hard it can be to withdraw from working life. Some seem to take two or three years to get used to it. So

that's why I'm trying to come to terms with it now, bit by bit, and will be spending several months actively planning my retirement. For me, that means: after one year, that's it, I'm done. That's when I will have moved on to my new life.

**So, do you think you can do nothing while doing nothing?**

No, I can never do nothing! But I will probably learn how to, at some point. I guess I will have the time for that soon.

**Thank you very much for the wonderful interview and all the best to you!**

Interview conducted by Silvia Zerbe.

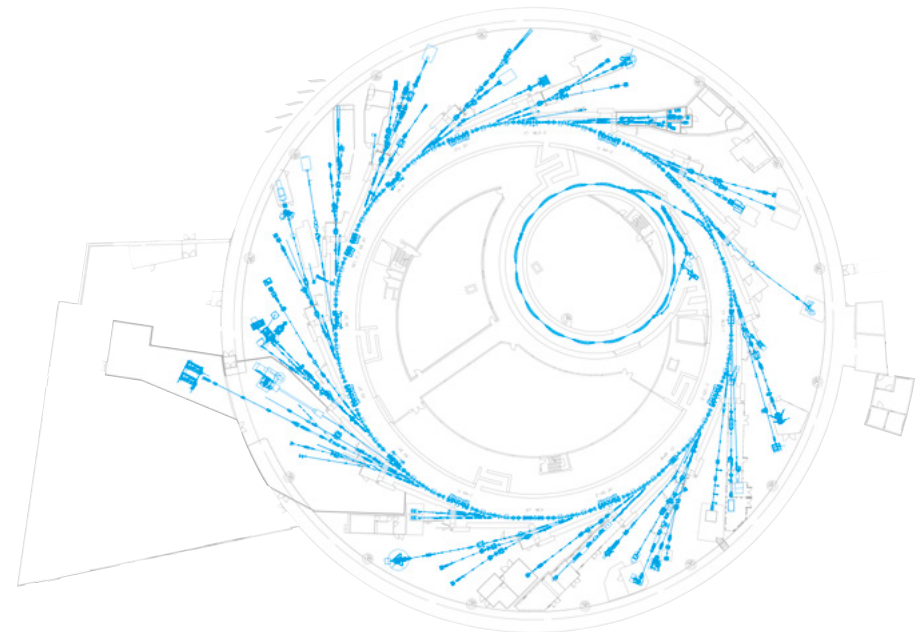



## To hoard like a hamster

The little hamster with its chubby cheeks does it just right: collecting and storing food for bad times. We are using the hoarding hamster as a model for renewables. We are working on converting the energy that the sun supplies us with and storing it for dark days when the sun is not shining. What seems to work effortlessly and efficiently in nature requires a huge effort

in research. In our one-minute video, we show how we explore the deepest secrets of nature and discover new materials. With curiosity and creativity, we develop efficient solutions for a climate-neutral future.

(sz)

# Sustainable fuels for aviation

In the research consortium CARE-O-SENE, scientists are looking for more efficient ways to produce synthetic kerosene for use in aviation. We interviewed Tobias Sontheimer of HZB and Dirk Schär of the participating company Sasol about what has to be done, what obstacles there are, and how aviation can be decarbonised.



## IN THE SPOTLIGHT: SUSTAINABLE KEROSENE

# “The market itself will push this issue”

**Tobias Sontheimer, the project CARE-O-SENE is set to run until 2025. Considering how ambitious the goals are, that’s not really a lot of time, is it?**

**Tobias Sontheimer (TS):** (Laughs) You’re right, it isn’t. But in the current situation, we can’t afford to settle for innovation cycles that will last 10 to 20 years. We need to be on a fast track to success.

**What makes you so confident it will be a success?**

**TS:** The consortium was established to bring the market leader in Fischer-Tropsch technology together with world-leading research institutes. At our institute alone, for example, we currently have 40 to 50 people working on this topic – and we are going at full steam.

**Dirk Schär (DS):** We are working on many tasks simultaneously: there is an analytical component to this project, there are experts who are dealing with sustainability issues, and there are those who are already thinking about how to roll out the technology quickly. These are all individual gears that mesh together precisely. If even one of them



**DIRK SCHÄR**

holds a doctorate in chemistry and works in Hamburg as the Technical Manager Marketing and Sales Catalysts at Sasol Germany GmbH. The petroleum and chemical company Sasol is the second largest industrial enterprise in South Africa, but also operates several plants in Europe, primarily in Germany and Italy.



**TOBIAS SONTHEIMER**

heads the Energy and Information Strategy Department at HZB. He holds a doctorate in physics and studied in Aachen and at Harvard University.

were missing, the project wouldn’t succeed.

**Fischer-Tropsch technology, which is at the heart of the process, is not exactly new.**

**DS:** That’s true. In fact, our company has been working in this field for seventy years. In South Africa, where our headquarters are, there is a lot of coal, and Fischer-Tropsch technology has long been used to produce

liquid fuels from it. “Coal to liquid” is what we call this, and “gas to liquid” then came along later. Now we want to take the next step. Synthetic fuels should no longer be produced from coal or gas, but rather from carbon dioxide, obtained as a by-product of cement production, for example, or extracted directly from the air.

**How exactly does it all work?**

**TS:** In Fischer-Tropsch technology, you convert a starting material – coal, gas or, as argued, carbon dioxide – into a synthetic gas. You can then convert this synthetic gas into different raw materials. One example is synthetic kerosene, which is what our project is all about.

**DS:** The Fischer-Tropsch method is agnostic to the source of carbon, as we like to say. So, you can use all kinds of starting materials. But the process does require a lot of energy.

**TS:** That is exactly where we come in. A key piece of the process is the catalyst, whose efficiency we want to increase. This’s what we are working on at BESSY II light source. We want to gain an understanding of the material properties of the catalyst at the microscopic level.

**That sounds rather abstract.**

**TS:** We are X-raying catalysts as they are being used, in operando, so that we can find out exactly how they are involved in the process. This information is crucial, in turn, for developing catalyst materials into something



Federal Chancellor Olaf Scholz (3rd from left) and the President of South Africa, Cyril Ramaphosa, (2nd from left) proclaimed in May 2022 in South Africa the joint support for CARE-O-SENE.

more advanced. We are pursuing many routes and have several materials in view, ranging from one catalyst that is already quite at an advanced developmental stage to another that promises to achieve even greater efficiency, but which still needs a lot of development. One long-term goal could be to move away from powder catalysts, as are currently used, and towards thin-film compositions that require less material. At the same time, we have to ensure that the production technology can be upscaled in principle – so that it can be used on the targeted large scale.

#### **How much of an efficiency gain do you expect for the production of synthetic kerosene?**

**DS:** We are sure that we can achieve a process yield of greater than 80 percent. That is about a 30 percent improvement over the current capacities.

#### **What would such a novel type of kerosene mean for aviation?**

**DS:** Blends already exist, although the fixed quotas of the EU are quite low and focus on other technologies, on biogenic kerosene. But the EU does have a roadmap, in which it envisages that the admixture should increase continuously, and that non-biogenic kerosene should also be added. Just to give an idea: blends of 5 percent are still envisaged for 2030, but towards 2050, 63 percent of blended kerosene ought to be produced synthetically.

#### **Can today's aircraft already fly on synthetic fuel alone?**

**TS:** Yes, from a purely technical point of view, that's not a problem at all. But there are regulatory obstacles: currently, only a maximum of five percent is allowed.

#### **The goal on the horizon for many researchers is to decarbonise aviation. Are synthetic fuels just a transitional technology until we have battery-powered electric aircraft or ones with turbines that run on hydrogen?**

**DS:** I guess you're drawing parallels from road traffic?

**Exactly. On roads, combustion engines are seen as obsolete models that are gradually being replaced – predominantly by electric vehicles.**

**TS:** Well, aviation can't really be compared to that, and the answer depends entirely on the field of application of an aircraft. Whether it's for long, medium or short-haul flights, for example, or how many passengers it has to carry. And, because of this, there are many simultaneous developments in research, all aimed at sustainable flying,

## CARE-O-SENE

Seven project partners from Germany and South Africa have joined forces in the research project CARE-O-SENE. Their aim is to develop and optimise catalysts used in Fischer-Tropsch (FT) processes. FT catalysts are essential for the large-scale production of sustainable aviation fuels (SAF), such as green kerosene, and optimising these catalysts improves the efficiency of the process. Unlike conventional fossil fuels, SAFs are made from green hydrogen and carbon dioxide. Industries like aviation can therefore benefit significantly from the resulting reduction in greenhouse gas emissions.

CARE-O-SENE will be a key enabler of Germany's National Hydrogen Strategy. The project has a total volume of EUR 40 million and is funded with EUR 30 million by the BMBF. In addition to HZB, Sasol Limited and Sasol Germany, the Karlsruhe Institute of Technology (KIT), the Fraunhofer Institute for Ceramic Technologies and Systems (IKTS), the University of Cape Town (UCT) and Ineratec GmbH are also involved.

There are several ways to produce sustainable kerosene. In the CARE-O-SENE project it is about obtaining aviation fuel from carbon dioxide (lower pathway). (This infographic remains in German because it comes from a German source.)

and all of them have their justification. For short-haul flights, there are other means of transport competing with aviation. **DS:** A battery for a medium or long-haul flight that can power an aircraft engine would weigh many tons. You would have to fly it back and forth the entire time as dead weight, whereas conventional aircraft become lighter as they fly because the kerosene gets used up. The primary discussion in aviation is not so much about whether we use internal combustion engines or not, but more about the most efficient way of getting an aircraft from point A to point B.

**How much does the new synthetic kerosene cost compared to conventional fuel?**

**DS:** It costs several times more at the moment. But that's no different from many other green technologies, which also have the same problem that they can only become

30

million Euro, this is the sum the Federal Ministry of Research invests in the optimisation of the production processes of sustainable kerosene.

**POWER-TO-LIQUID-VERFAHREN (PTL)**

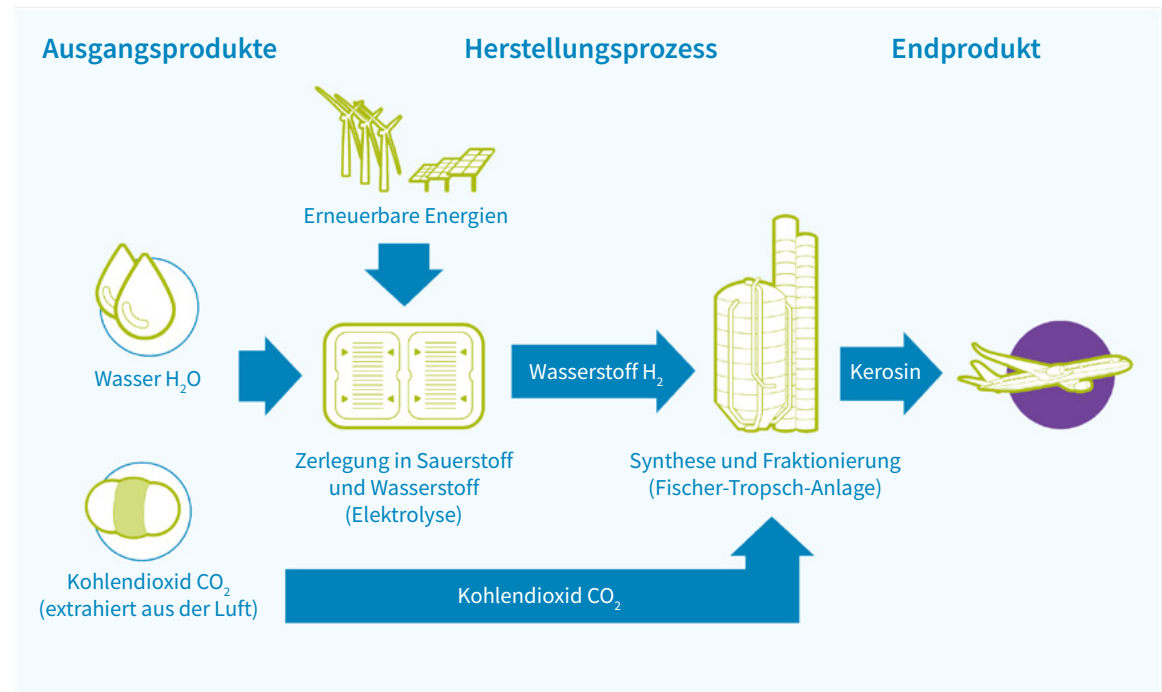

Quelle: Klimaschutz-Portal.aero auf Grundlage von Air Transport Action Group (ATAG)

Klimaschutz-Portal.aero

established through predefined quotas. But we are doing research precisely so that we can make production more efficient and thus get the prices to come down.

**Let's take another look at your project. In the target year 2025...**

**DS:** ... we want to have developed a catalyst to the point where we can upscale it.

**That means the catalyst can't be used yet?**

**TS:** In our project, we cover the production of everything from just a few micrograms of catalyst material to a full tonne. So that is already a first step towards commercialisation.

**DS:** But we at Sasol, alone, produce many thousands of tonnes of catalysts per year. The things we are developing in CARE-O-SENE need to be designed in a way that existing



**Federal Chancellor Scholz in South Africa:** On 24 May 2022, he presented the ambitious CARE-O-SENE project to the general public.

production facilities can be adapted to them.

**Now that we have looked at the technical and the economic side, what is the situation on the regulatory side? Are they already prepared to approve synthetic kerosene for regular operation?**

**DS:** From what I see, the quotas that the EU stipulates are based on production capacities. There would be no point in stipulating a 30 percent admixture right now if it turns out we won't have the capacities for it within the next few years. This is precisely why the blending quotas are still quite conservative; they first want to make sure that sufficient production capacities can even be created in Europe. But we are not fazed by that:

we can already tell that people will commit voluntarily to blending quotas above those prescribed, and so the market itself will push this issue.

**TS:** The political situation has also changed dramatically and, with it, people's view of energy security. Making a substantial contribution towards transforming aviation is our goal. And that is exactly what we are working on.

*Interview conducted by Kilian Kirchgeßner.*

**“Making a substantial contribution towards transforming aviation is our goal.”**

**Tobias Sontheimer**



## FIGURES FROM HZB

# How do we get to work?

That's what we asked the employees at HZB. Here we present the most important results from the mobility survey.



388

employees took part in the **online survey** on mobility behaviour.

25

% of respondents take the **bicycle** to work in summer. In winter, the figure is 15%.

16

% of respondents would use **carpooling**. However, only 41 % know about the carpooling pin-board on the Intranet.

73

% are aware of the **job ticket** for public transport, which is financially supported by HZB. 17 % already use this job ticket.

32

% travel to work by **car** in winter. 26 % take the car in summer.

36

% come to work by **public transport** in winter. In summer it is 28 %.

24

kilometer is the **average commuting distance** to work.

36

% would switch to a bicycle if there were more and safer **bike parking facilities** at HZB.

13

% of respondents plan to buy an **electric or hybrid car**. 7 % want to buy an **e-bike**.

1,3

days the respondents **work from home**.

WE MOURN  
THE LOSS OF OUR FORMER COLLEAGUE

## Prof. Dr. Alexei Erko

who passed away on the 22nd of October 2022  
at the age of 70 after a short and severe illness.

Alexei Erko worked for more than 20 years at the electron storage ring BESSY II. His worldwide renowned expertise in X-ray optics was a significant contribution to the successful research at synchrotron radiation sources.

His started his career as a scientist and later as Head of the Laboratory for X-Ray Optics and Technology at the Russian Academy of Sciences in Chernogolovka. In 1994, Erko started working in the Optics workgroup of BESSY II. There, he was involved in the design and construction of crystal monochromator beamlines and worked on X-ray holography. In 2011, he became the Head of the newly established Institute of Nanometre Optics and Technology. In the same year, Freie Universität Berlin appointed him as an Honorary Professor for

Experimental Physics. Up until his retirement in 2018, Erko and his team made important developments. This includes the construction of a grating production facility at HZB and the development of multilayer-coated diffraction gratings for the tender X-ray spectrum. The results of his groundbreaking work on reflection zone plates are still relevant to this day, and are applied at many synchrotron radiation and FEL sources. In recognition of his work, Alexei Erko received the 2018 European Innovation Award on Synchrotron Radiation. With the passing of Alexei Erko, we have lost too soon an outstanding and internationally highly esteemed scientist. We will deeply miss his modest and polite nature, his curiosity, his enthusiasm, and his open approach to discussions.

WE MOURN THE LOSS OF OUR FORMER  
LONG-SERVING SCIENTIFIC DIRECTOR

## Prof. Dr. Michael Steiner

who passed away on 5 November 2022  
at the age of 79 in Berlin.

From 1998 to 2008, Prof. Michael Steiner was the scientific director of the Hahn-Meitner-Institut (HMI). During that time, he prepared the merger of the HMI with BESSY GmbH. His aim was to unite neutron and photon research under one roof.

Michael Steiner was a world-renowned expert in research with neutrons. His experiments on antiferromagnetically coupled spin chains made an important contribution to the theory of topological phase transitions. Steiner was a professor at TU Berlin and the University of Mainz.

Michael Steiner started as a researcher in 1974, in the HMI-Neutron Scattering workgroup. In 1994, he became Director of the Berlin Neutron Scattering Center (BENSC) at the Berlin research reactor BER II. Neutron research at the HMI became known throughout the world

for innovative experimental possibilities and an intellectually stimulating research environment, which Michael Steiner played a major role in shaping. In addition, he put solar energy research on solid footing by making it the second pillar of the HMI.

After his retirement in 2009, Michael Steiner contributed his long-standing expertise as the spokesperson for the European Neutron Scattering Association. In 2010, Michael Steiner was awarded the Order of Merit 1st Class of the Federal Republic of Germany for his tireless commitment to strengthening the German and European scientific landscape.

Michael Steiner was a highly respected expert, a visionary who had brilliant ideas and to whom we owe a great deal. We will miss him greatly.

# What is the future of our two sites in Adlershof and Wannsee?

HZB has developed a strategy for the future development of the two sites. This has now been approved by the HZB supervisory board.

In the summer of 2021, the directors and the Works Council worked together with employees from the Facility Management department and representatives of the BMBF to develop an overarching strategy for the site development up until 2040. This is based on analyses of the existing buildings and projected requirements, as well as the available areas and options for further construction at the two campuses. But there will also be several POF periods (Helmholtz-Förderperioden) during this time, as well as the decision of whether or not BESSY III will be built on a new property. The concept for sustainable site development, decided by the Supervisory Board in the spring of 2022, takes such uncertainties

and options into account and consists of multiple phases.

“The research activities are increasingly relocating to the Adlershof campus. The need for space is growing there, for labs and offices. And the development plan also allows for further new construction and consolidation measures there,” explains HZB architect Heike Kampher. For example, the new CatLab building for catalysis research is currently being built right in the vicinity of BESSY II light source.

“The research activities are increasingly relocating to the Adlershof campus. The need for space is growing there, for labs and offices.”

Heike Kampher

Even more buildings are planned for the later stages of construction – if funding is secured. At the same time as the CatLab building, a new supply technology building will be built and the biolab expanded. For the successor synchrotron BESSY III, a location on the Adlershof campus is currently being investigated in detail. Once BESSY III is constructed, the large areas in the experimental hall of BESSY II could continue to be used for microscopy or other laboratories, for example. On the Wannsee campus, by contrast, the

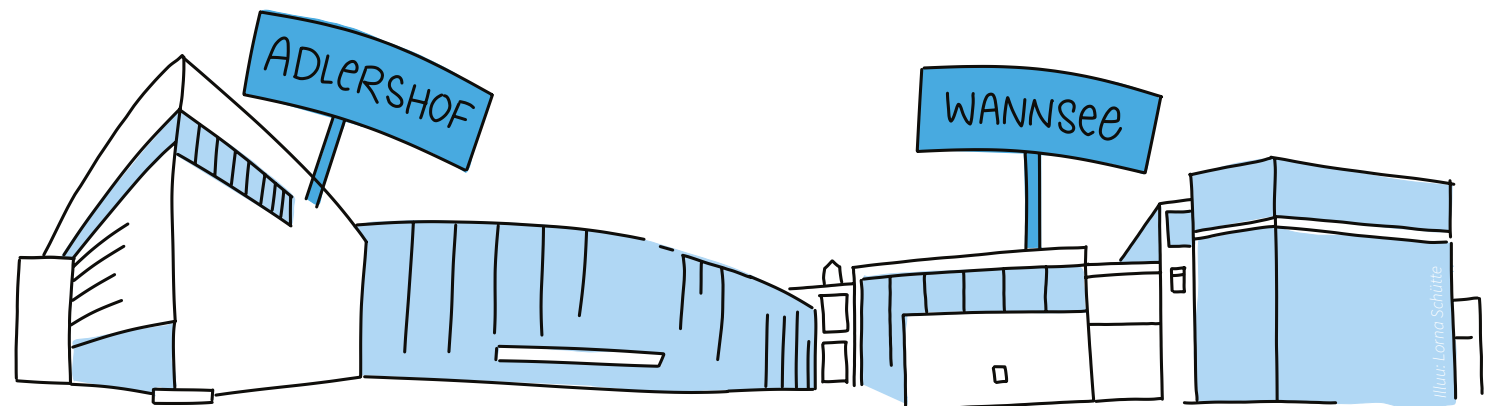

On the campus Wannsee (aerial picture, 2011) there will be new free space after the dismantling of the research reactor. The state of Berlin could establish a technology park here.



Picture: HZB/D. Laubner

top priority among structural measures is the dismantling of the research reactor BER II. In addition, the eye tumour therapy facility is to be modernised. “There are no new research buildings planned for Wannsee. Rather, above all, there will be renovations for maintaining the condition of the buildings in use,” says KampherM.

In the long term, the Wannsee campus will be opened to third parties. For employees whose jobs are not tied down to the Wannsee location, a relocation to Adlershof within the next 15 years is envisaged. This of course requires the appropriate buildings being available there. The departments affected will be included in the planning in good time. The State of Berlin will develop a utilization concept for the new space gained at Wannsee. Suggestions already exist: for example, a technology transfer park could be created there with start-ups and labs, which HZB would support with its expertise.

■ BY ANTONIA RÖTGER

“In Wannsee there will be, above all, renovations for maintaining the condition of the buildings in use.”

Heike KampherM

According to the development plan, there is still space for new buildings on the campus Adlershof (aerial picture, 2018).



Picture: HZB/D. Laubner

# Tailwind for adopted HZB strategy

During their bi-annual meeting on 7 November 2022, the HZB Supervisory Board has adopted the HZB strategy.

Thanks to intensive and fruitful discussions many employees have contributed to the development of a mission and a strategy for the HZB, which focuses primarily on major societal challenges. The strategy shows us, which path the HZB will follow until 2030 and beyond. Highlighted in a brochure you can find all the key building blocks of the strategy.



“At HZB, we have outstanding, dedicated employees breathing life into our strategy every day with their expertise. With creativity, curiosity and joy in discovery, we will continue to do our part in protecting the climate and helping to usher in an era without fossil fuels.”

Thomas Frederking and Bernd Rech

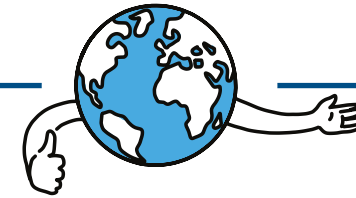

## OUR MISSION

We strive to achieve a climate neutral society through science and innovation. This is why we drive materials discovery, create new sustainable technologies and empower the research community in realising this goal.

Let's  
make a  
difference!

In pursuing our mission, we take responsibility in our daily work for our ecological footprint.

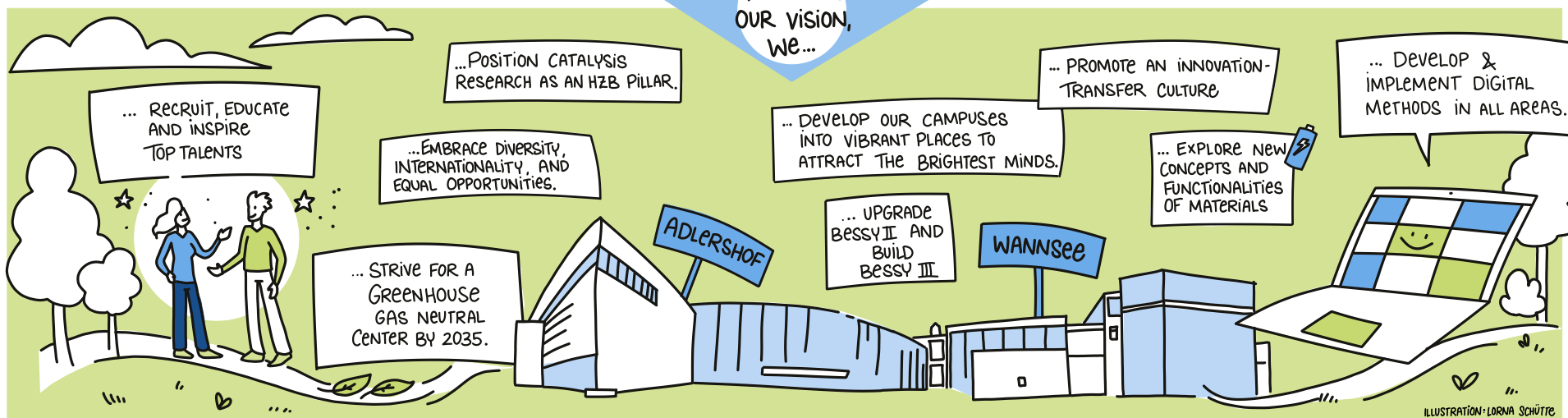
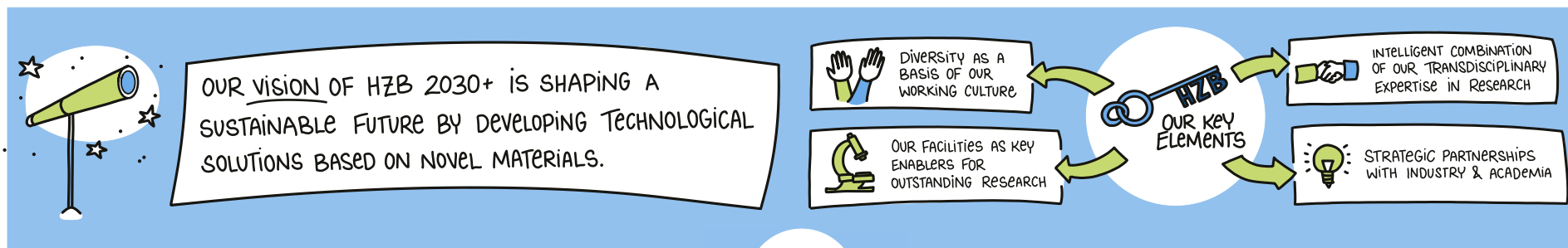
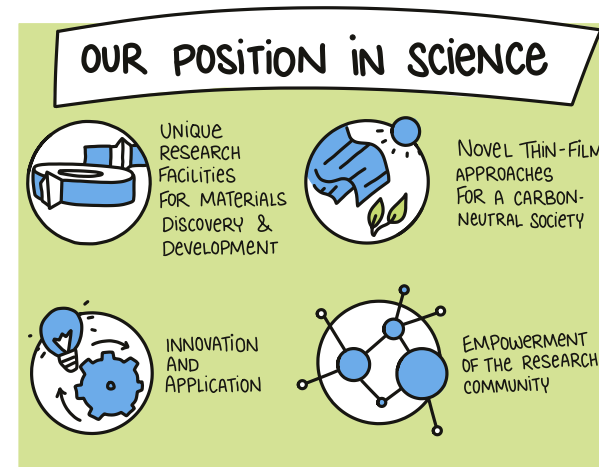
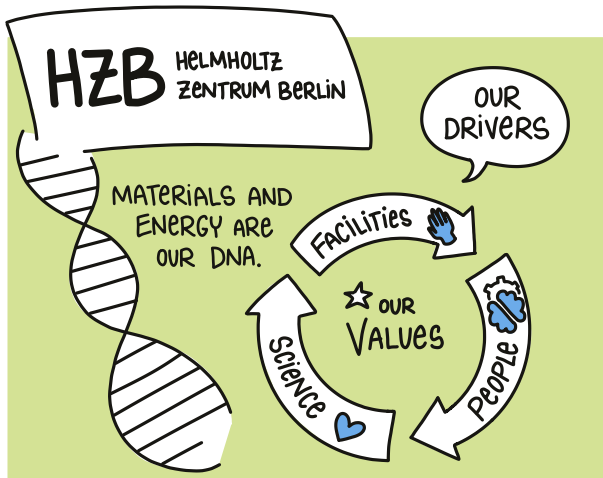



## CONGRATULATIONS



**MICHELLE BROWNE**

The ISE-Elsevier Prize for Applied Electrochemistry goes this year to Michelle Browne. It is endowed with 2000 euro. At HZB Browne is building up a Helmholtz Junior research group and works on electrocatalytic active materials.



**CHARLOTTE VAN DIJCK**

received the “Graduate Student Award” for her outstanding paper. The prize was awarded at the autumn meeting of the European Materials Research Society (E-MRS) in Warsaw.



**YVONNE TOMM**

Congratulations Yvonne Tomm. She received the “CrystEngComm Oral Presentation Prize” at the 7th European Conference on Crystal Growth in Paris.



**EIKE KÖHNEN**

has been awarded the Tiburtius Prize of the Berlin University of Applied Sciences for his dissertation. Therein he showed how the efficiency of perovskite/silicon tandem solar cells can be increased to over 29 percent.

## PERSONNEL

**FELIX BÜTTNER**

has led a junior research group at HZB. Now he has accepted a call to the University of Augsburg. Within the framework of a joint research group, he will continue his investigations of magnetic skyrmions at HZB.

**ALEXANDER GRAY**

comes to HZB as a Humboldt Fellow and conducts research on novel 2D quantum materials. He wants to further develop depth-resolved X-ray methods at BESSY II. Gray works at Temple University in Philadelphia, USA.

**NEW OMBUDSPERSONS**

The Management Board has appointed new ombudspersons for good scientific practice. For questions concerning scientific work you can reach out to **Manfred Weiss**, **Sebastian Fiechter**, **Annette Pietsch** and **Michael Tovar**.

**RUTGER SCHLATMANN**

has been appointed Chairman of the European and Innovation Platform for Photovoltaics (ETIP PV). It advises independently on energy policy issues and on the expansion of photovoltaics in Europe.



## PICTURE PUZZLE

Every metre is put to good use in the BESSY II experimental hall. This is a perfect challenge for our picture puzzle. Can you find the 7 mistakes? You can win:

1x HZB umbrella, 1 x USB stick, 1 x HZB bag with gummy bears as a consolation prize.

Closing Date: 15.01.2023

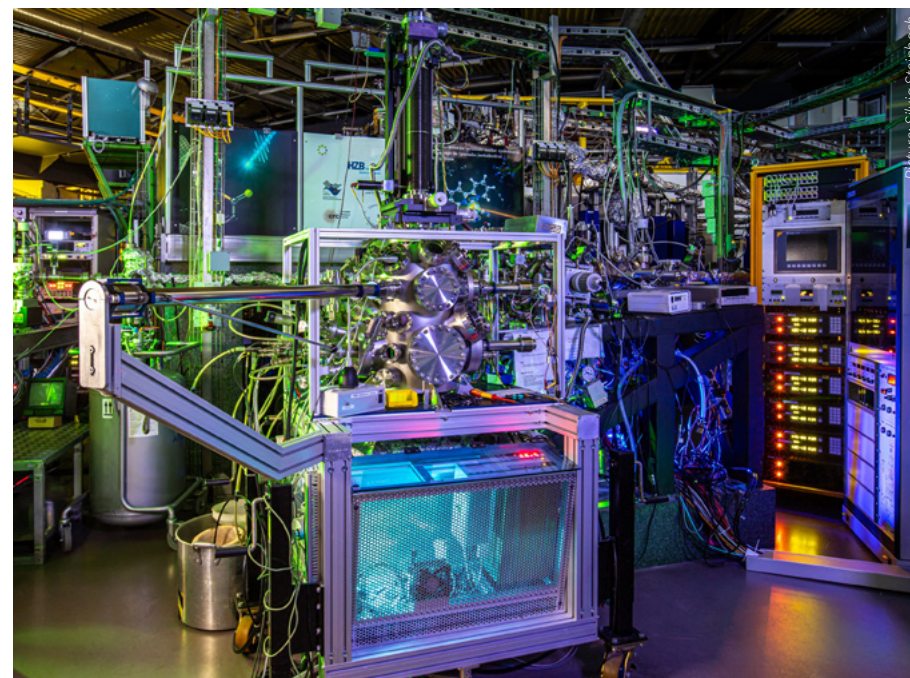
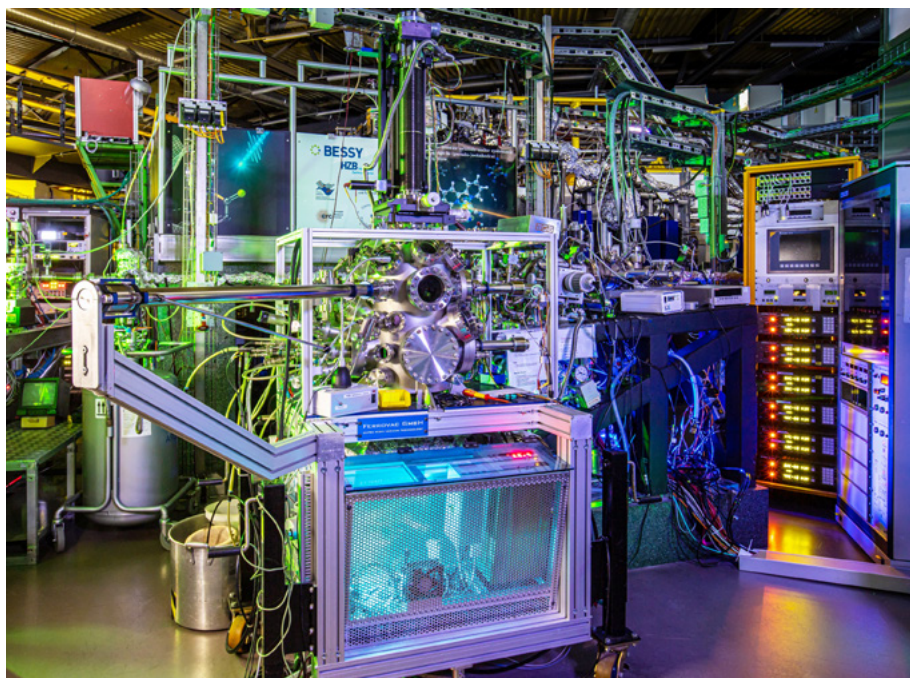

Please mark all the mistakes clearly in the image and send us an email to [lichtblick@helmholtz-berlin.de](mailto:lichtblick@helmholtz-berlin.de). Alternatively, you can send your solution by internal mail or post to: **Helmholtz-Zentrum Berlin, keyword: lichtblick competition, Communications Department, Hahn-Meitner-Platz 1, 14109 Berlin**. We will notify the winners by email. With your entry you agree that your name will be published in the next issue. The legal recourse is excluded.

### WINNER AT THE PROOFREADING QUIZ

The last puzzle (lichtblick 50, the proofreading quiz) was a tough one and we only received two correct entries. The lot has decided: congratulations go to **Cathrin Rellier**, who worked in the proton therapy department, for her practised proofreading eye!



## VISIT OF THE FEDERAL MINISTER OF RESEARCH

# MAKING GERMANY A HYDROGEN REPUBLIC

On 25 October, the Federal Minister of Education and Research, Bettina Stark-Watzinger, was in Berlin-Adlershof to visit the Catalysis Laboratory (CatLab). CatLab is a research platform of Helmholtz-Zentrum Berlin and the Max Planck Society, dedicated to catalysis research that will deliver important innovations for achieving a green hydrogen economy. Upon her visit to the CatLab, the minister gained an insight into the latest technological advancements on producing and characterising thin-film catalysts and special methods for operando analytics and digital catalysis.

“I want to make Germany a hydrogen republic. We are already a world leader when it comes to technologies for producing green hydrogen. Next, we need to accelerate the ramp-up of the hydrogen economy. The Federal Ministry of Research has been investing in the necessary research and development for many years now. CatLab is an excellent example of this.”

Bettina Stark-Watzinger

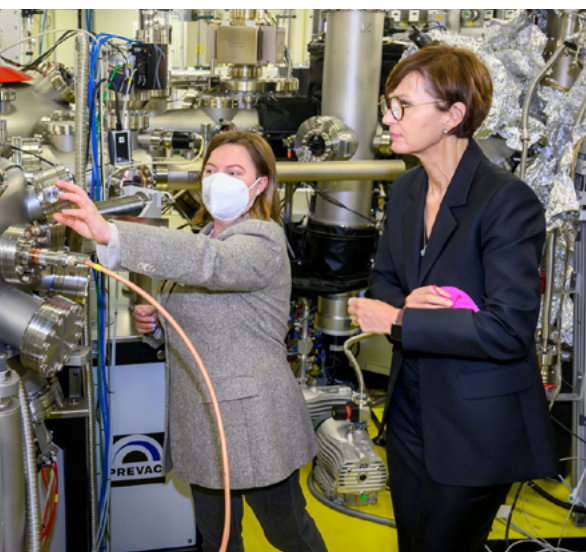

The Federal Minister (3rd from left) visits BESSY II light source. From left to right: Thomas Frederking (administrative Director HZB), Bernd Rech (scientific Director HZB; CatLab Project Manager), Bettina Stark-Watzinger (Federal Minister), Antje Vollmer (Spokesperson BESSY II), Beatriz Roldán-Cuenya (Director FHI), Robert Schlögl (Director FHI; CatLab Project Manager).





## RECIPES FROM ALL OVER THE WORLD

### Ingredients (6 persons)

6 slices of fish, approx. 3 cm thick (Whiting, Mahi Mahi, Striped Bass, Namorado)  
 4 plantains sliced diagonally (1.5 cm thick)  
*for a vegan version*  
 Salt and pepper  
 1 tbsp of soy oil  
 (alternatively: sunflower or any neutral-taste oil)  
 1 large lime (only for the fish version)  
 1 ½ tbsp of minced garlic  
 6 tomatoes, finely chopped  
 3 white onions, finely chopped  
 1 bunch of chopped coriander  
 2 tbsp of annatto  
 (alternatively: sweet paprika)

# Moqueca Capixaba

*With Mayara da Silva Santos from Brazil*

First marinate the fish with half of the garlic, salt, pepper and the lime juice.

Preparing the soffrito (the base): heat the oil in a pan and add the remaining garlic; wait until it gets a golden color. Add half of the onions and fry until it also becomes golden. Add half of the tomatoes, half of the chopped coriander, the annatto/paprika and salt as you wish. Cook until it gets a tomato sauce texture.

Add the marinated fish or the plantains with the remaining tomatoes and onions. Cover the pan (at medium to high heat) and wait until it's fully cooked (aprox. 25 min for the fish and 10 min for the plantains).

Finish by sprinkling the remaining coriander on top. Serve it with rice.

Fun fact: traditionally, this dish is cooked in handmade clay pots, made by craftswomen from the Goiabeiras region (state of Espírito Santo, Brazil). The knowledge involved in the manufacturing of these pots is considered an intangible heritage.

*Bom apetite!*



*“The best advice I have ever been given is you can always learn something from any situation. Even the bad examples can teach you what not to do.”*

**Mayara da Silva Santos,**  
 Department Highly sensitive  
 X-Ray Spectroscopy.

Picture: Michael Setzpfandt



## Notes of HZB

# There is always a solution!

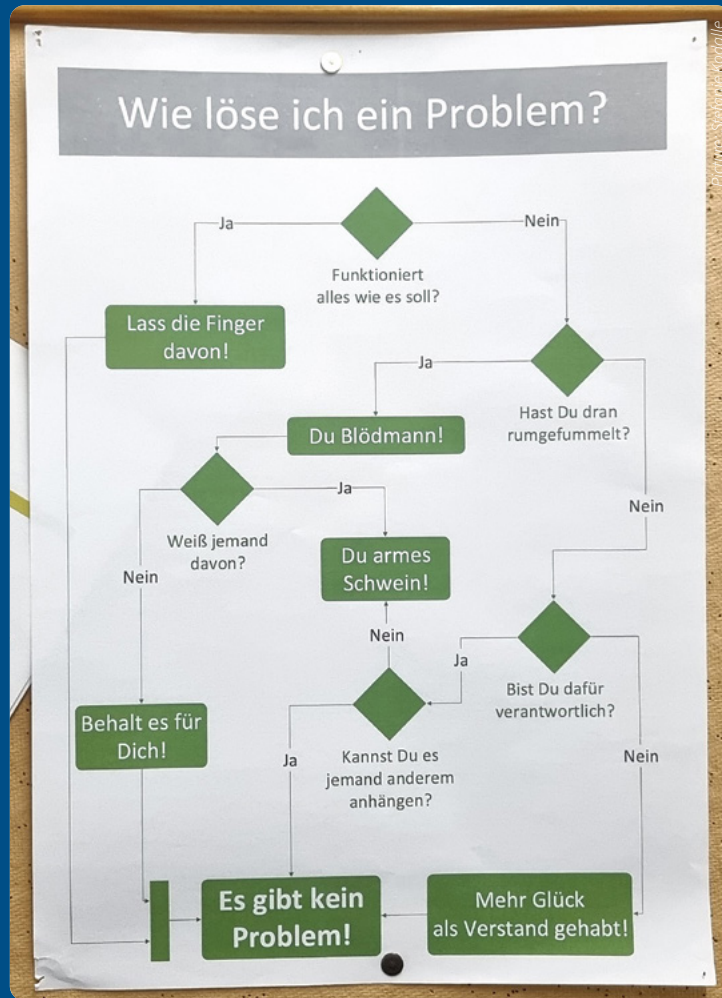

Have fun exploring the German way of solving problems!  
This poster was found in Wannsee.



## Season Greetings and Happy New Year!

We wish you all wonderful and relaxing holidays with your loved ones, lots of presents, new warm socks, contemplative calories & treats – and *einen guten Rutsch* of course! See you in 2023!

### IMPRINT

**EXTERNAL ISSUE – PUBLISHER:** Helmholtz-Zentrum Berlin für Materialien und Energie GmbH, Hahn-Meitner-Platz 1, 14109 Berlin; **EDITORIAL STAFF:** communications department, lichtblick@helmholtz-berlin.de, Tel.: (030) 80 62-0; **EDITORIAL MANAGEMENT:** Silvia Zerbe (editor-in-chief), Dr. Ina Helms (v.i.S.d.P.); **JOURNALISTS FOR THIS ISSUE:** Kilian Kirchgessner, Stefanie Kodalle, Florentine Krawatzek (fk), Dr. Antonia Rötger (arö), Silvia Zerbe (sz);

**LAYOUT AND PRODUCTION:** Josch Politt, graphilox; **PRINT PUBLICATION** (in German): 300 magazines; **PRINTED** on 100% recycled paper, FSC-certified and awarded with the label Blauer Umweltengel and EU-Ecolabel:

